

ROBINET HELIUM DOUBLE SUR TABLE

Références: ROBHELT2

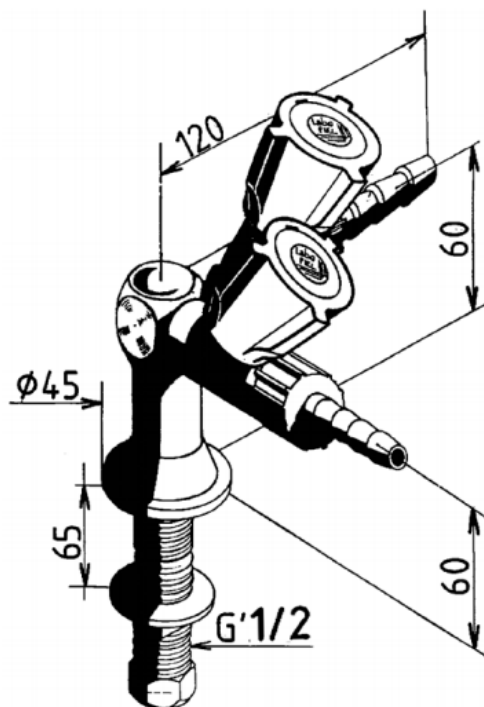

DESCRIPTIF

Prise à deux robinets à 90° pour paillasse ciment, pour hélium. Têtes à clapet guidé hors eau NF, embouts cannelés démontables \varnothing 6mm, raccordement queue filetée M G'1/2, saillie 102mm. Croisillons, embase et rondelle d'embase en polypropylène suivant les codes de couleur de la norme européenne NF EN 13792. Serrage maximum 100mm. Corps et embouts en laiton avec revêtement en Nylolac noir





































































DIMENSIONS

MARQUE / REFERENCE GROSSERON / REFERENCE FABRICANT

SANIFIRST / ROBHELT2 / 76152

*Dans le cadre de l'évolution de ses produits, Grosseron se réserve le droit d'apporter des modifications sans préavis.
Cette fiche est la propriété de Grosseron. Elle ne peut être ni reproduite, ni utilisée même partiellement sans autorisation*

RÉFÉRENCES DE PIÈCES DÉTACHÉES*

Tête	Désignation du fluide	Norme	Volant	Embase	Plaque de volant	Rondelle d'embase	Pastille
Clapet 2,5 tours	Eau potable froide (H90)	EN	 Réf. 76129	 Réf. 76556	 Réf. 76130	 Réf. 76731	 Réf. 76131
Clapet 2,5 tours	Eau potable chaude (H90)	EN	 Réf. 76129	 Réf. 76556	 Réf. 76130	 Réf. 76676	 Réf. 76482
Clapet 2,5 tours	Eau non potable (H95)	EN	 Réf. 76129	 Réf. 76556	 Réf. 76612	 Réf. 76731	 Réf. 76131
Clapet 2,5 tours	Eau déminéralisée (H97)	EN	 Réf. 76129	 Réf. 76556	 Réf. 76729	 Réf. 76732	 Réf. 76505
Clapet 2,5 tours	Argon / Ar (H70)	EN	 Réf. 76436	 Réf. 76507	 Réf. 76389	 Réf. 76667	 Réf. 76438
Clapet 2,5 tours	Azote / N2 (H71)	EN	 Réf. 76436	 Réf. 76507	 Réf. 76130	 Réf. 76733	 Réf. 76469
Clapet 2,5 tours	Hélium / He2 (H72)	EN	 Réf. 76436	 Réf. 76507	 Réf. 76389	 Réf. 76667	 Réf. 76505
Clapet 2,5 tours	Oxygène / O2 (H73)	EN	 Réf. 76436	 Réf. 76507	 Réf. 76446	 Réf. 76731	 Réf. 76131
Clapet 2,5 tours	Anhydride carbonique / CO2 (H75)	EN	 Réf. 76436	 Réf. 76507	 Réf. 76446	 Réf. 76734	 Réf. 76735
Clapet 2,5 tours	Air comprimé (H76)	EN	 Réf. 76436	 Réf. 76507	 Réf. 76446	 Réf. 76698	 Réf. 76435
Clapet 2,5 tours	Hydrogène / H2 (H77)	EN	 Réf. 76725	 Réf. 76728	 Réf. 76730	 Réf. 76676	 Réf. 76482
Clapet 2,5 tours	Acétylène C2H2 (H78)	EN	 Réf. 76726	 Réf. 76554	 Réf. 76729	 Réf. 76733	 Réf. 76469
1/4 de tour sécurité	Gaz domestiques (H94)	EN	 Réf. 76234	 Réf. 76554	 Réf. 76236	 Réf. 76698	-
Clapet 2,5 tours	Vide (H93)	EN	 Réf. 76467	 Réf. 76550	 Réf. 76389	 Réf. 76667	 Réf. 76438

*Lot de 10 pièces